

THE WAY TO PLAY!

VINYL PLAY SETS VOLUME 23



THANK YOU for your interest in Adventure World Play Sets!



OUR VISION, MISSION, & PURPOSE

Our Vision is to be the premier play set crafter today and tomorrow.

Our Mission is to act with integrity in all we do to create the safest play and best entertainment experiences that grown-ups trust and children love.

Our Purpose is to create unforgettable childhood memories.

Our dealer commitment is to build strong relationships with our national network of preferred dealers based on respect, trust, and our personal values that guide our day to day actions.

**Our swing sets are proudly made and
manufactured in the USA.**



OUR GUARANTEE/WARRANTY

CONTENTS

As parents ourselves, we wanted a warranty that is simple, easy to understand, and protects the purchaser. We felt our warranty should reflect our confidence in the high-quality swing set that we offer. That is why we came up with our industry-leading warranty.

Warranty protection from date of original purchase.

1 YEAR WARRANTY

No questions asked! If anything on your swing set breaks, fades, or affects the integrity of the swing set, we will send a crew out (within 200 miles of any of our warehouses) to fix the issue. The only exception is willful damage, normal wear and tear, or an act of God. If you are located farther than 200 miles from our closest warehouse, we will ship the part to the closest dealer or directly to your house.



5 YEAR WARRANTY

Your swings, slides and accessories are guaranteed against manufacturer defects. We will send the part to the closest dealer in your area. If you don't live close to a dealer, pay for the shipping, and the part will arrive at your house.

20 YEAR WARRANTY

Your swing set frame is guaranteed against manufacturer defects. We will send the part to your closest dealer. If you don't live close to a dealer, pay for the shipping, and the part will arrive at your house.

How is that for simple?

| | |
|---------------------------------------|---|
| Thank You!..... | Inside Front Cover |
| Out Guarantee/Warranty | 1 |
| Safety and Quality Features | 2-3 |
| Package Overview | 4-5 |
| Our Packages..... | 7-35 |
| Just for Grown-ups (Seating) | 36 |
| Design Your Play Set Online | 37 |
| Customize Your Play Set: | |
| STEP 1 - Choose Your Tower Unit | 38-39 |
| STEP 2 - Choose Your Colors | 40-41 |
| Structural Beam Colors |  |
| <small>*Premium Colors</small> | Almond White* Brown* |
| Roof, Railing & Bracket Colors |  |
| | Green Blue Red Black Brown |
| STEP 3 - Choose Your Roof..... | 42-43 |
| STEP 4 - Choose Your Accesses | 44-45 |
| STEP 5 - Choose Your Connectors | 46-47 |
| STEP 6 - Choose Your Swing Beam | 48-49 |
| STEP 7 - Choose Your Swings..... | 50-51 |
| STEP 8 - Choose Your Slides..... | 52-53 |
| STEP 9 - Choose Your Accessories..... | 54-55 |
| Choose Your Free Item..... | 55 |
| Our Customers | 56 |
| Frequently Asked Questions..... | 57 |
| Rubber Mulch, Mats & Curbing..... | 58-60 |
| Parts Dimensions | 61 |

THE SAFE WAY TO PLAY



Vinyl covering means children can hold-tight without getting splinters!

Adventure World Play Sets are made in the USA and constructed following the highest standards. The following quality and safety features are standard at no extra cost on all of our play sets.

QUALITY

- Use of pressure-treated lumber (rather than untreated wood which is susceptible to rotting in a few years) covered with vinyl combines the strength of wood with the easy care of vinyl. Vinyl covering also resists wood boring insects and bees.
- Use of heavy-duty walled vinyl adds strength, is fade resistant and is easy to clean; occasional rinsing is all you need to keep your play set looking great.
- Powder-coated brackets resist peeling and rusting.
- Stainless steel bolts and chains will not rust.
- Heavy-duty corner construction is through-bolted with two steel angles; we do not use wood lags, which connect by being driven only half way into the beams.
- Long-lasting poly-lumber roofs – instead of canvas – resist high winds.
- Durable structural parts and sturdy construction create stable play sets that won't tip in high winds or as children swing.

SAFETY

- Vinyl creates a safe, smooth surface that is splinter-free without surface cracks, checks or knotty appearance.
- Entrance ladders come standard with non-slip steps and safety rails.
- Rubber-coated swing chains provide a soft, pinch-free grip.
- Wood-grain texture on decking and rock walls increases traction.
- No shortcuts by using exposed wood on decking underside that risks splinters and cuts from cracks in wood; our play sets feature vinyl covering throughout.
- Heavy-duty swing hangers feature spring clip for easy height adjustment and swing change.
- Two ground anchors included with each swing beam.
- No overhead climbers with swings attached.



Stainless Steel Bolts Throughout



Will not rust

Heavy-Duty Corner Construction



Through bolted with two steel angles

Long-Lasting Poly Lumber Roof



Resists high winds

Stainless Steel Heavy-Duty Swing Hangers



With spring clip for easy height adjustment and swing change

Stainless Steel Chains



Resists rusting

Powder-Coated Brackets

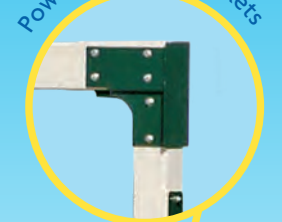

Resist peeling and rusting

Tube Slide



Heavy-duty with stainless steel hardware

Safety Rails



Included on all entrance ladders

Entrance Ladder

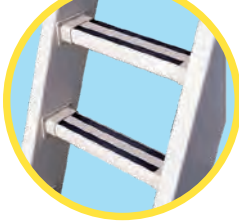

Features non-slip steps

Underside of Our Decking



No exposed wood

Decking and Rock Wall



Feature wood-grain texture for increased traction

Two Ground Anchors

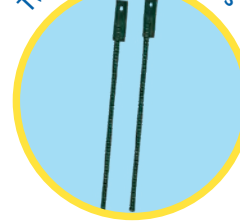

Included with each swing beam

Rubber-Coated Swing Chain



For a soft, pinch-free grip



OUR PACKAGES

A quick look at all our sets. There's something here for everyone!

BUSY BASE CAMP



#B44-6 p. 8



#B46-9 p. 9



#B55-1 p. 10

ADVENTURE GYM



#A-3 p. 7



#B55-4 p. 11



#B55-7 p. 12



#B66-2 p. 13

DISCOVERY DEPOT



#D48-1 p. 14



#D48-3 p. 15



#D48-9 p. 16



#D510-6 p. 17



#D510-8 p. 18



#D68-8 p. 19



#F514-4 p. 20



#F514-6 p. 21



#F514-9 p. 22-23

FANTASY FORTRESS

FROLIC ZONE



#FA33-2 p. 24



#FA33-7 p. 25



GIGGLE JUNCTION



#GA44-6 p. 26



#GA55-2 p. 27



#GA55-6 p. 27

HAPPY HIDEOUT



#H68-2 p. 28



#H68-7 p. 29



#H68-9 p. 30



#H68-30 p. 31



IMAGINATION STATION



#IH68-3 p. 32-33

JOLLY JAMBOREE



#J88-1 p. 34-35

JUST FOR GROWN-UPS



Adult
Love Seat
p. 36



Grown-up
Picnic Table
p. 36

RUBBER MATS, MULCH & CURBING

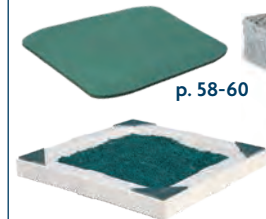

p. 58-60



THE ACTIVE WAY TO PLAY

According to the Centers for Disease Control and Prevention, children should aim for one hour or more of physical activity per day. Playing on play sets gets kids' hearts pumping and strengthens muscles and bones.

Let the
adventure
begin!



Build Your Adventure!

OUR PACKAGES

On the following pages, you'll find photos and dimensions of each tower as part of pre-created packages. Packages reflect each available tower size — single, double and triple towers with single or multiple level decks of varying dimensions.

CUSTOMIZE YOUR PLAY SET

Packages are available as is, or can be used to get ideas for a completely customized play set. Customize your play set by beginning with Step 1 "Choose Your Tower Unit" on page 38 where you'll find the details of all tower options and available deck dimension for each tower type.



A freestanding swing beam

Package includes:

- 3-Position Single Beam
- 2nd End Post for Free Standing
- 2 Belt Swings
- Trapeze

ADVENTURE GYM

PACKAGE #A-3

Minimum area for proper installation:..... 16'x15'
Recommended border:62'
Recommended mulch:.....1 tons
Weed guard:.....240 sq. ft.
Height:.....8'

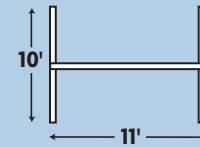

For safety, add a 6' play area around the perimeter of the play set.

A great starter play set to get their imaginations going!



BUSY BASECAMP

Each Busy Basecamp play set features a single level 5' deck.

PACKAGE #B44-6

Minimum area for proper installation:..... 25'x24'
Recommended border: 98'
Recommended mulch:..... 2 tons
Weed guard:..... 600 sq. ft.
Height:..... 10.5'

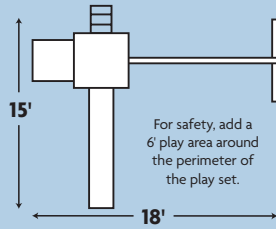

Package includes:

- Tower: 4' x 4' 5' Deck Height
- Vinyl Roof
- Entrance Ladder
- 5' Rock Wall
- 3-Position Single Beam
- 2 Belt Swings
- Trapeze
- Wonder Wave Slide



This play set is all your active kids need to get moving in the fresh air!

**BEST
SELLER!**

BUSY BASECAMP



Package includes:

- Tower: 4' x 6'
5' Deck Height
- Vinyl Roof
- 5' Rock Wall
- Gangplank
- 3-Position Single Beam
- 2 Belt Swings
- Trapeze
- Wonder Wave Slide

PACKAGE #B46-9

Minimum area for proper installation:..... 26'x26'
 Recommended border: 104'
 Recommended mulch:..... 3 tons
 Weed guard:..... 676 sq. ft.
 Height:..... 10.5'

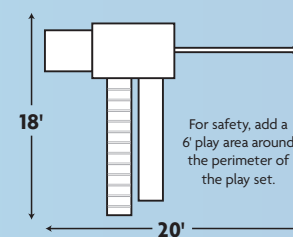

BUSY BASECAMP

PACKAGE #B55-1

Minimum area for proper installation:.....26'x20'
Recommended border: 92'
Recommended mulch:.....2 tons
Weed guard:.....520 sq. ft.
Height:.....11.5'

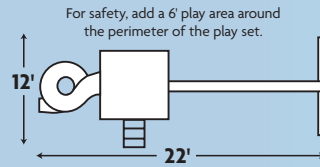

Package includes:

- Tower: 5' x 5'
5' Deck Height
- Vinyl Roof
- Entrance Ladder
- 3-Position Single Beam
- 2 Belt Swings
- Trapeze
- Twisty Turbo Slide
- Step & Slide Adapter



BUSY BASECAMP



Package includes:

- Tower: 5' x 5'
5' Deck Height
- Vinyl Roof
- Entrance Ladder
- 5' Rock Wall
- 3-Position Single Beam
- Space-saver Monkey Bar (10' Long)
- 2 Belt Swings
- High Back Baby Swing
- Wonder Wave Slide

PACKAGE #B55-4

Minimum area for proper installation:..... 30'x26'
 Recommended border: 112'
 Recommended mulch:..... 3 tons
 Weed guard:.....780 sq. ft.
 Height:..... 11'

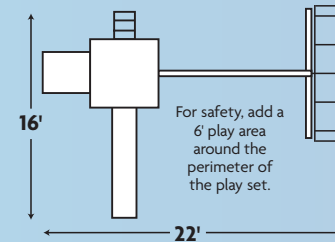

BUSY BASECAMP

PACKAGE #B55-7

Minimum area for proper installation:.....29'x26'
Recommended border:110'
Recommended mulch:..... 3 tons
Weed guard:.....754 sq. ft.
Height:.....11.5'

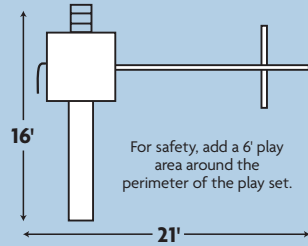

Package includes:

- Tower: 5' x 5'
5' Deck Height
- Longer Post to Attach High Beam
- Vinyl Roof
- Entrance Ladder
- 4-Position Extra High (10') Single Swing Beam
- 2 Belt Swings
- Full Bucket Baby Swing
- Hammock Swing
- Wonder Wave Slide
- Fireman's Pole



This package features an upgraded extra high 10' swing beam!

BUSY BASECAMP

PACKAGE INCLUDES A
5' ROCK WALL
ON BACK OF SET



Package includes:

- Tower: 6' x 6'
5' Deck Height
- Vinyl Roof
- Entrance Ladder
- 5' Rock Wall
- Gangplank
- 3-Position Single Beam
- 2 Belt Swings
- Trapeze
- 2 Wonder Wave Slides

PACKAGE #B66-2

Minimum area for proper installation:..... 34'x27'
Recommended border:..... 122'
Recommended mulch:..... 3 tons
Weed guard:.....918 sq. ft.
Height:..... 11'

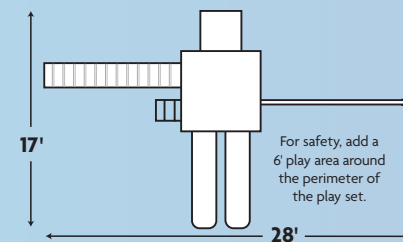

DISCOVERY DEPOT

Each Discovery Depot play set features two levels of decking.

PACKAGE #D48-1

Minimum area for proper installation:.....24'x18'
Recommended border: 84'
Recommended mulch:.....2 tons
Weed guard:..... 432 sq. ft.
Height:.....10.5'

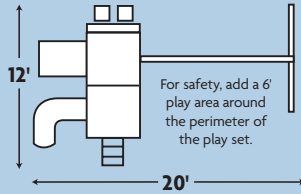

Package includes:

- Tower: 4' x 8' Split Level
- 2 Belt Swings
- 3' & 5' Deck
- Full Bucket Baby Swing
- Vinyl Roof
- 3' Super Spiral Slide
- 3' Entrance Ladder
- 5' Rock Wall
- 3-Position Single Beam
- Lemonade Stand



Discover an extra level to get little legs climbing and creative minds soaring.



DISCOVERY DEPOT

This package features an upgraded extra high 10' swing beam!



Package includes:

- Tower: 4' x 8' Split Level
5' & 7' Deck Heights
- Vinyl Roof
- Entrance Ladder
- 3-Position Extra High (10') Single Swing Beam
- 2 Belt Swings
- Trapeze
- Wonder Wave Slide
- Twisty Turbo Slide

PACKAGE #D48-3

Minimum area for proper installation:..... 25'x28'
Recommended border:106'
Recommended mulch:..... 3 tons
Weed guard:.....700 sq. ft.
Height:..... 12.5'

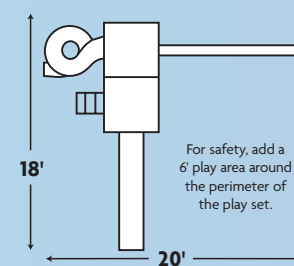

For safety, add a 6' play area around the perimeter of the play set.



DISCOVERY DEPOT

PACKAGE #D48-9

Minimum area for proper installation:.....50'x25'
 Recommended border:150'
 Recommended mulch:.....5 tons
 Weed guard:.....1,250 sq. ft.
 Height:.....12.5'

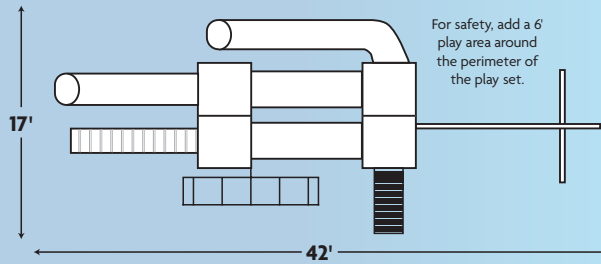

Package includes:

- 2 Towers: 4' x 8' Split Level 5' & 7' Deck Heights
- 2 Vinyl Roofs
- Grand Stairway
- Grand Gangplank
- Wobbly Bridge
- Bridge
- 4-Position Single Beam
- Space Saver Monkey Bar
- 1 Belt Swing
- Trapeze
- Ball
- 2-Chain Rubber Tire
- 7' Sidewinder Slide
- 7' Tunnel Express Slide

PACKAGE INCLUDES A SIDEWINDER SLIDE ON BACK OF SET



DISCOVERY DEPOT



Package includes:

- Tower: 5' x 10' Split Level
5' & 7' Deck Heights
- 2 Vinyl Roofs
- 5' Rock Wall
- Gangplank
- 3-Position Single Beam
- 2 Belt Swings
- Trapeze
- Extreme Ripple
Rush Slide

PACKAGE #D510-6

Minimum area for
proper installation:.....36'x20'
Recommended border:112'
Recommended mulch:.....3 tons
Weed guard:.....720 sq. ft.
Height:.....13'

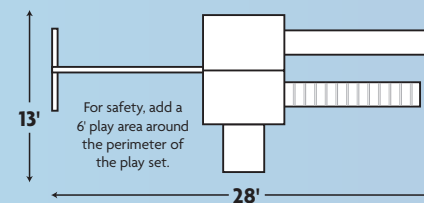

DISCOVERY DEPOT

PACKAGE #D510-8

Minimum area for proper installation:.....46'x26'
 Recommended border:144'
 Recommended mulch:.....4 tons
 Weed guard:.....1,196 sq. ft.
 Height:.....13'

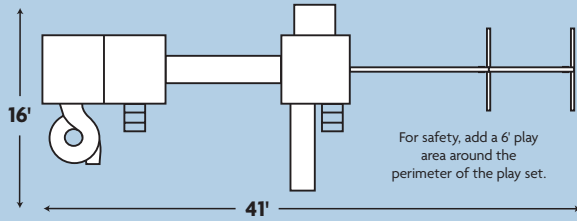

Package includes:

- Tower 1 - Discovery Depot: 5' x 10' Split Level 5' & 7' Deck Heights
- Vinyl Roof
- Tower 2 - Busy Base Camp: 5' x 5' 5' Deck Height
- Vinyl Roof
- 2 Entrance Ladders
- 5' Rock Wall
- Bridge
- 3-Position Single Swing Beam
- 2-Position Single Swing Beam
- 2 Belt Swings
- Trapeze
- Adult Love Seat
- Wonder Wave Slide
- Twisty Turbo Slide

OUR BASES MAKE A GREAT SANDBOX!

Find sandbox covers and other great accessories on page 54.



PACKAGE INCLUDES A
5' ROCK WALL
 ON BACK OF SET



DISCOVERY DEPOT

PACKAGE INCLUDES A
TIC-TAC-TOE PANEL
ON BACK OF SET



**BEST
SELLER!**

Package includes:

- Tower - 6' x 8' Split Level
5' & 7' Deck Heights
- Vinyl Roof
- Entrance Ladder
- Rock Wall
- 3-Position Extra High (10')
Single Swing Beam
- 2 Belt Swings
- Trapeze
- Wonder Wave Slide
- Twisty Turbo Slide
- Tic-Tac-Toe Panel

PACKAGE #D68-8

Minimum area for
proper installation:.....27'x28'
Recommended border:110'
Recommended mulch:.....3 tons
Weed guard:.....756 sq. ft.
Height:.....12.5'

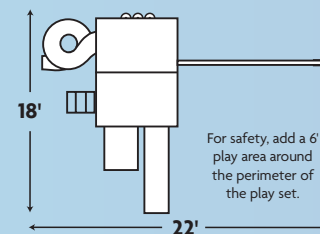

FANTASY FORTRESS

Each Fantasy Fortress play set features three levels of decking.

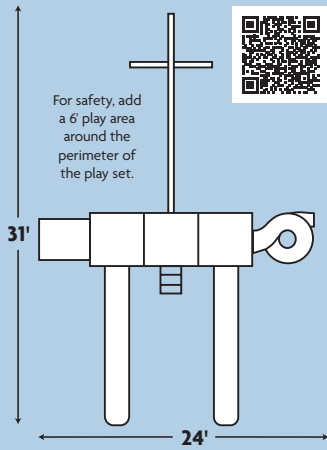

PACKAGE #F514-4

Minimum area for proper installation:.....40'x32'
Recommended border:144'
Recommended mulch:.....5 tons
Weed guard:.....1,280 sq. ft.
Height:.....12.5'

Package includes:

- Tower: 5' x14' Split Level
5' & 7' Deck Heights
- 2 Vinyl Roofs
- Entrance Ladder
- 7' Rock Wall
- 4-Position Single Beam
- 2 Belt Swings
- Trapeze
- High Back Baby Swing
- 2 Extreme Ripple Rush Slides
- Twisty Turbo Slide

Take imaginative play to another level – three levels, that is!



FANTASY FORTRESS

**PACKAGE INCLUDES A
7' ROCK WALL AND
FIREMAN'S POLE
ON BACK OF SET**



Package includes:

- Tower: 5' x 14' Split Level
5' & 7' Deck Heights
- 3 Vinyl Roofs
- Entrance Ladder
- 7' Rock Wall
- Gangplank
- 2 3-Position Single Beams
- 3 Belt Swings
- Trapeze
- Ball
- High Back Baby Swing
- Ripple Rush Slide
- Extreme Ripple Rush Slide
- Fireman's Pole

PACKAGE #F514-6

Minimum area for
proper installation:..... 40'x33'
Recommended border:146'
Recommended mulch:.....5 tons
Weed guard:..... 1,320 sq. ft.
Height:..... 13'

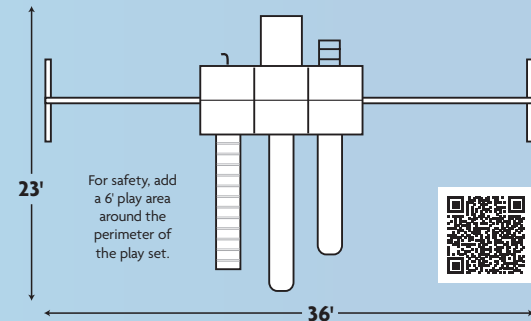

FANTASY FORTRESS

Package includes:

- Tower: 5' x 14' Split Level
5', 7' & 9' Deck Heights
- 3 Vinyl Roofs
- Entrance Ladder
- Gangplank
- Extreme Ripple Rush Slide
- Twisty Turbo Slide for 9' High Deck
- Side Winder Slide for 5' High Deck
- Side Winder Slide for 9' High Deck
- Tic-Tac-Toe Panel

PACKAGE INCLUDES A
TIC-TAC-TOE PANEL
ON BACK OF SET



FANTASY FORTRESS



PACKAGE #F514-9

Minimum area for proper installation:.....26'x30'
Recommended border:112'
Recommended mulch:.....3 tons
Weed guard:.....780 sq. ft.
Height:.....16'

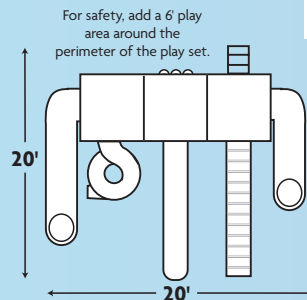

FROLIC ZONE

Each Frolic Zone play set features 3'x3' 5' high deck.

PACKAGE #FA33-2

Minimum area for proper installation:.....23'x18'
Recommended border: 82'
Recommended mulch:.....2 tons
Weed guard:.....414 sq. ft.
Height:..... 8'

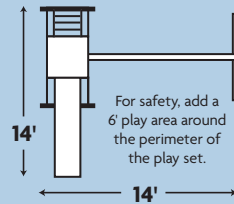

Package includes:

- Tower: 3' x 3' A-frame
5' Deck Height
- Entrance Ladder
- 3-Position Single Beam
- 2 Belt Swings
- Trapeze
- Wonder Wave Slide

Compact, yet has plenty of room for fun and games. Your kids can frolic and play for hours!



FROLIC ZONE

PACKAGE INCLUDES A
SMALL ROCK WALL
ON BACK OF SET

Package includes:

- Tower: 3' x 3' A-frame
5' Deck Height
- Vinyl Roof
- Entrance Ladder
- Small Rock Wall
- 3-Position Single Beam
- 2 Belt Swings
- Trapeze
- Wonder Wave Slide

PACKAGE #FA33-7

Minimum area for
proper installation:.....16'x30'
Recommended border: 92'
Recommended mulch:.....2 tons
Weed guard:..... 480 sq. ft.
Height:.....10'

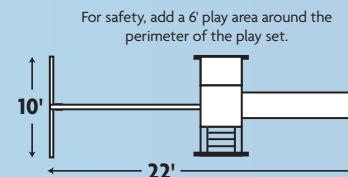

GIGGLE JUNCTION

Each Giggle Junction play set features an A-Frame with a 5' Deck.

PACKAGE #GA44-6

Minimum area for proper installation:.....32'x19'
Recommended border:102'
Recommended mulch:.....2 tons
Weed guard:.....608 sq. ft.
Height:.....10.5'

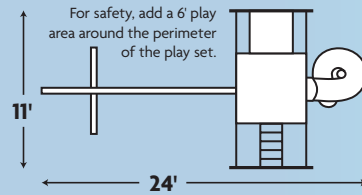

Package includes:

- Tower: 4' x 4' A-Frame
5' Deck Height
- Vinyl Roof
- Entrance Ladder
- Rock Wall
- 4-Position Single Beam
- 2 Belt Swings
- Trapeze
- 4 Chain Rubber Tire Swing
- 5' Super Spiral Slide

A simple solution for inviting fun and laughter into your back yard.



GIGGLE JUNCTION

**PACKAGE INCLUDES A
5' ROCK WALL
ON BACK OF SET**



Package includes:

- Tower: 5' x 5' A-Frame 5' Deck Height
- Vinyl Roof
- Entrance Ladder
- 5' Rock Wall
- 2-Position Accessory Arm
- 2 Belt Swings
- Plastic Tire Swing (3-Chain)
- Wonder Wave Slide

PACKAGE #GA55-2

Minimum area for proper installation:.....26'x18'
 Recommended border:88'
 Recommended mulch...2 tons
 Weed guard:..... 468 sq. ft.
 Height:.....11'

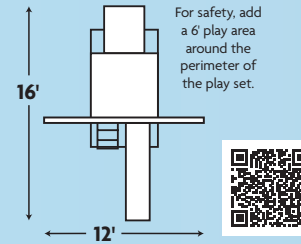

Package includes:

- Tower: 5' x 5' A-Frame 5' Deck Height
- Vinyl Roof
- Entrance Ladder
- Small Rock Wall
- Small Chain Ladder
- 4-Position Single Beam
- 2 Belt Swings
- High Back Baby Swing
- Hammock Swing
- Wonder Wave Slide
- 5' Sidewinder Slide

PACKAGE #GA55-6

Minimum area for proper installation:..... 30'x27'
 Recommended border:226'
 Recommended mulch... 3 tons
 Weed guard:.....810 sq. ft.
 Height:.....11'

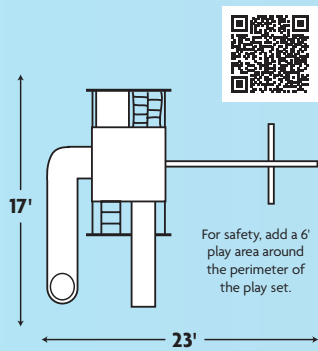

**PACKAGE INCLUDES A
SMALL ROCK WALL
SMALL CHAIN LADDER
ON BACK OF SET**

HAPPY HIDEOUT

PACKAGE #H68-2

Minimum area for proper installation:.....21'x24'
Recommended border:90'
Recommended mulch:.....2 tons
Weed guard:..... 504 sq. ft.
Height:..... 12'

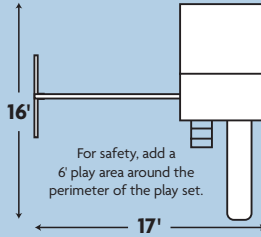

Each Happy Hideout play set features a playhouse on 5' high deck.

Package includes:

- Tower: 6' x 5' Playhouse on 6' x 8' Deck 5' Deck Height
- Entrance Ladder
- 3-Position Single Beam
- 2 Belt Swings
- Trapeze
- Ripple Rush Slide



The playhouse is beautifully finished both inside and out, and comes with a standard roof.

BEST SELLER!

A quiet place for kids to make-believe, or a space to scream and shout with friends — no grown-ups allowed!



HAPPY HIDEOUT



Package includes:

- Tower: 6' x 5' Playhouse on 6' x 8' Deck 5' Deck Height
- Gangplank
- 4-Position Single Beam
- 2 Belt Swings
- Trapeze
- Plastic Glider with Single Beam Adapter
- Ripple Rush Slide
- Twisty Turbo Slide
- Step and Slide Adapter

PACKAGE #H68-7

- Minimum area for proper installation:.....30'x26'
- Recommended border:112'
- Recommended mulch:.....3 tons
- Weed guard:.....780 sq. ft.
- Height:.....12'

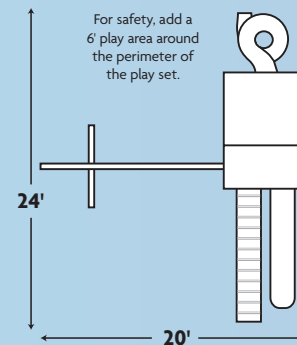

HAPPY HIDEOUT

PACKAGE #H68-9

Minimum area for proper installation:.....29'x27'
Recommended border:112'
Recommended mulch:.....3 tons
Weed guard:.....783 sq. ft.
Height:.....12'

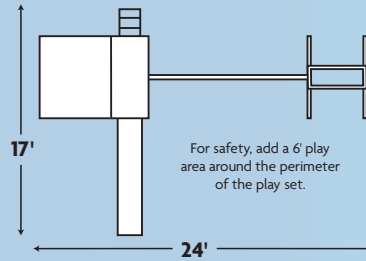

Package includes:

- Tower: 6' x 5' Playhouse on 6' x 8' Deck 5' Deck Height
- Entrance Ladder
- 3-Position Single Beam
- 2 Belt Swings
- Full Bucket Baby Swing
- Easy Rider Glider
- Wonder Wave Slide
- Tic-Tac-Toe Panel



HAPPY HIDEOUT



Package includes:

- 6' x 5' Playhouse on 6' x 8' Deck
- Mounted on 4x4 skids for use on ground level

PACKAGE #H68-30

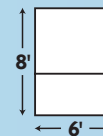

For safety, add a 6' play area around the perimeter of the play set.



IMAGINATION STATION

This play set features three towers and multiple levels.

PACKAGE #IH68-3

Minimum area for proper installation:.....48'x35'
Recommended border:166'
Recommended mulch:.....6 tons
Weed guard:.....1,680 sq. ft.
Height:..... 13'

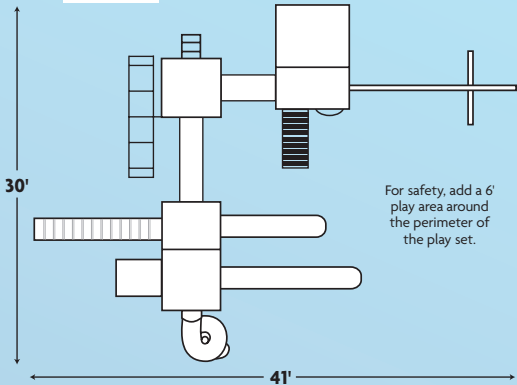

This tower creates the
Imaginations will



IMAGINATION STATION

ultimate backyard play land.
climb as high as your kids!



PACKAGE
INCLUDES A
**7' ROCK WALL,
GANGPLANK, &
SPACE SAVER
MONKEY
BAR**



Package includes:

- Tower 1: Happy Hideout:
6' x 5' Playhouse on
6' x 8' Deck
5' Deck Height
- Tower 2: Busy Basecamp:
5' x 5'
5' Deck Height
- Vinyl Roof
- Tower 3: Discovery Depot:
5' x 10' Split Level
5' and 7' Deck Heights
- Vinyl Roof
- Entrance Ladder
- Grand Stairway
- 7' Rock Wall
- Gangplank
- Crawl Tube
- Bridge
- 4-Position Single Beam
- Space Saver
Monkey Bar
- 2 Belt Swings
- Trapeze
- Plastic Glider with
Single Beam Adapter
- Ripple Rush Slide
- Extreme Ripple
Rush Slide
- Super Spiral Slide
- Bubble Panel

JOLLY JAMBOREE

The Jolly Jamboree play set features five levels and small ladders to

PACKAGE #J88-1

Minimum area for proper installation:..... 32'x36'
Recommended border: 136'
Recommended mulch:..... 4 tons
Weed guard:..... 1,152 sq. ft.
Height:..... 15'

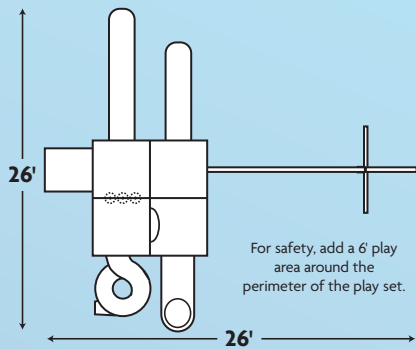

Some kids are jolly close to the ground, while others are jollier closer to the sky!

PACKAGE INCLUDES A
5' AND 7'
 RIPPLE RUSH SLIDE
ON BACK OF SET

PACKAGE INCLUDES A
7' ROCK WALL
ON BACK OF SET



climb from one level to the next.

JOLLY JAMBOREE

With five levels, the Jolly Jamboree is sure to please everyone!

Package includes:

- Tower: 8' x 8' Tower
1', 3', 5', 7', & 9'
Deck Heights
- 3 Vinyl Roofs
- 7' Rock Wall
- 4-Position Single Beam
- Plastic Glider
- 2 Belt Swings
- Trapeze
- Tunnel Express for
3' High Deck
- Twisty Turbo Slide for
9' High Deck
- Ripple Rush Slide
- Extreme Ripple Rush Slide
- Tic-Tac-Toe Panel
- Bubble Panel



PACKAGE INCLUDES A
5' AND 7'
RIPPLE RUSH SLIDE
ON BACK OF SET

PACKAGE INCLUDES A
7' ROCK WALL
ON BACK OF SET

JUST FOR GROWN-UPS

A special place to relax and enjoy watching little ones at play! Our swing sets are designed for kids, but this seating is meant just for adults!

Made from the same quality materials as our play sets, these items are built to last and are virtually maintenance-free!

GROWN-UP LOVE SEAT SWING

You've got it made in the shade! You and your sweetie will be comfy and swinging in style with this elegant seating solution.



6'x6' with frame and roof.

Grown-up Love Seat Swing and Wheel Chair Swing available with or without roof.

WHEEL CHAIR SWING WITH FRAME



5' PARK BENCH

Simple and practical, this seating solution will have you asking to be "benched."



GROWN-UP PICNIC TABLE

Enjoy your vinyl picnic table for a family picnic or birthday party in your own back yard after kids play on their Adventure World Play Set.

Available in 3'x6' and 3'x8' (not shown). Available in almond or white.



We also offer these grown-up-friendly swings that will attach to your play set!

See page 50 & 51 for more details!



DESIGN YOUR OWN CUSTOM PLAY SET

online at adventureworldplaysets.com

Our easy to use design center helps you create the play set of your dreams. The only limit is your imagination.

FOLLOW THESE EASY STEPS TO GET STARTED:

Go to **Adventureworldplaysets.com**

Click on the 3-D rendering of the play set in the middle of the page.

Enter your zip code in the pop-up window to launch a new browser window for the 3D Design Center. When it finishes loading, you will see an empty back yard to start building your play set in!

Click the tower icon on the left to choose a tower.

Your tower will be “attached” to your cursor. Click to release it in the middle of your back yard.

Click the roofs icon to view your roof choices.

A yellow dot will appear on areas of the set where you can place the roof.

Click the swing beams icon on the left to view your swing beams choices. The yellow dots on the set indicate where you may attach your swing beam.

Continue adding accessories, connectors and accessories by choosing a category on the left and specific items on the right side of the screen.

Play set elements may be easily rotated by selecting them and then using the rotate tools.

Making changes is easy. Simply choose an element you wish to remove, and click the **trash can icon** to delete.

Click the question mark icon in the lower left hand corner of the

interface to bring up a handy list of keyboard shortcuts.

Easily recolor any part of your play set using the paint brush tool. You will be shown the colors available for each item.

When you have finished designing your set, click the envelope icon to email yourself a preview of the set along with the set details, and even get a quote on your dream play set from a local dealer!



**NOTE: Set renderings are for visual reference only and may not be 100% accurate.*

STEP 1

CHOOSE YOUR TOWER UNIT

Choose from single, double and triple towers with single or multiple levels. Plus, we offer a variety of sizes to fit any yard and budget.



BUSY BASECAMP

As shown on pages 8-13.

Single level with deck dimensions:

| Dimensions | Deck Height | | |
|------------|-------------|-------|-------|
| | 3 ft. | 5 ft. | 7 ft. |
| • 4'x4' | ✓ | ✓ | |
| • 4'x6' | | ✓ | ✓ |
| • 5'x5' | ✓ | ✓ | ✓ |
| • 6'x6' | | ✓ | |



DISCOVERY DEPOT

As shown on pages 14-19.

Double level 5' and 7' deck heights with deck dimensions:

- 4'x8'
- 6'x8'
- 5'x10'
- Bi-tower



FANTASY FORTRESS

As shown on pages 20-23.

Triple level 5' and 7' deck heights with deck dimensions:

- 5'x14' (2 – 7' deck heights and 1–5' deck height)
- 5'x14' (2 – 5' deck heights and 1–7' deck height)

Triple level 5', 7' & 9' deck heights with deck dimensions:

- 5'x14'



FROLIC ZONE

As shown on pages 24-25.

A-Frame 5' deck height

- 3'x3' tower

Rock wall on this set must be the small rock wall



GIGGLE JUNCTION

As shown on pages 26-27.

A-Frame 5' deck height with deck dimensions:

- 4'x4'
- 5'x5'
- 6'x5'

The tower sets the stage for your Adventure World Play Set, and creates a destination for children's imaginations to run wild.



HAPPY HIDEOUT

As shown on pages 28-31.

Playhouse with a single level 5' deck height – 6'x8' deck

Standard with roof over deck. Also available with or without roof over deck.



IMAGINATION STATION

As shown on pages 32-33.

Tri-tower

- See page 33 for deck dimensions



JOLLY JAMBOREE

As shown on pages 34-35.

5 levels, 1', 3', 5', 7' and 9' deck heights with deck dimensions:

- 8'x8'

STEP 2

CHOOSE YOUR COLORS

Choose your structural beam color and then choose your accent color. Accent and accessory colors—including rock wall rocks—can be mixed upon request at no additional charge.**

***Premium colors require an additional charge.*

STRUCTURAL BEAM COLORS

Follow the rainbow of color options to match any style.

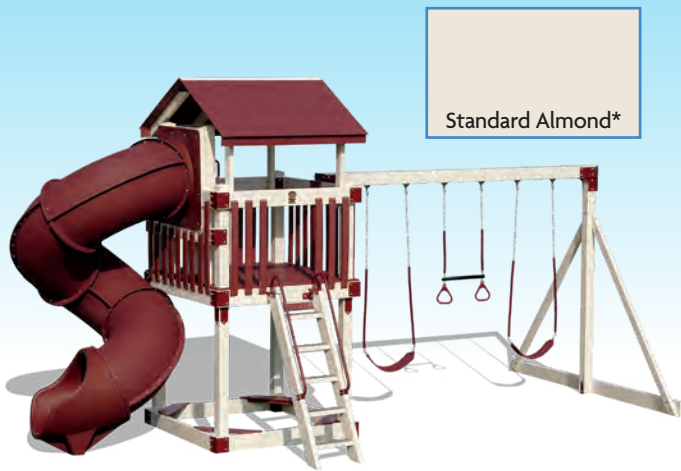

STANDARD ALMOND VINYL*



PREMIUM WHITE VINYL*

Shows dirt more easily than other colors



PREMIUM BROWN VINYL*

Wood-Grain Brown*

This premium color offers the aesthetic, natural appearance of wood, combined with the easy care of vinyl. Here's what makes this color special:

- Matching brown roof, rails, and brackets are standard
- The same durable, fade-resistant, splinter-free, maintenance-free surface as the standard vinyl
- A wood appearance that blends into natural surroundings, hides dirt, and never requires staining

** You can now choose to have red, blue, green, brown, and black poly and brackets on any color vinyl.*

ROOF, RAILING & BRACKET COLORS

Standard accent colors for roof, rails and brackets:

- Red, green, blue, black, and brown

Standard accessory colors:

- Most swings are available in blue, green, red or gray; see page 50 & 51 for details.
- Slides are available in blue, green, red or gray; see page 52 & 53 for details.

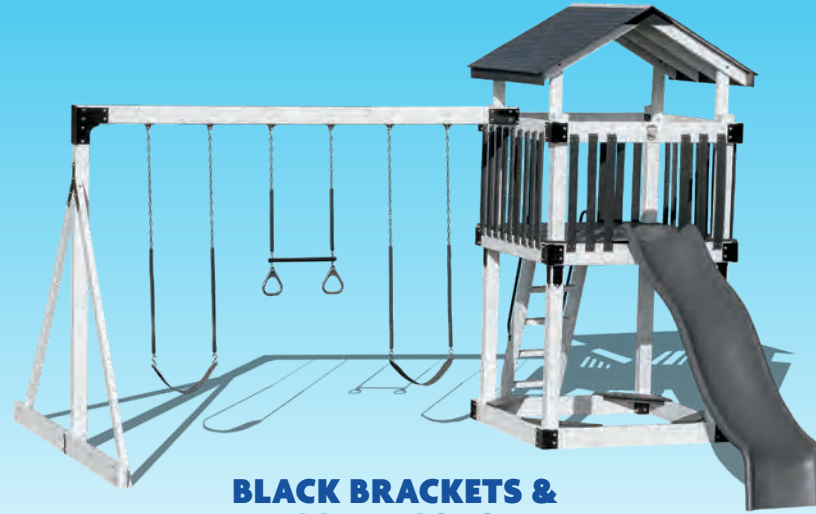

BLACK BRACKETS & ACCENT COLOR



RED BRACKETS & ACCENT COLOR



GREEN BRACKETS & ACCENT COLOR



BLUE BRACKETS & ACCENT COLOR



BROWN BRACKETS & ACCENT COLOR

When choosing your colors, keep in mind that most swings are available in red, blue or green. See page 50-51 for details.

STEP 3

CHOOSE YOUR ROOF

Adventure World Play Sets' long-lasting, poly-lumber roofs resist high winds and are made with recycled HDPE plastics – the kind of plastics found in milk bottles.

The big bad wolf can huff and puff, but he won't blow this roof down!

VINYL PEAK ROOF

Roofs are available in green, red, blue, black or brown.



DOUBLE ROOF

A double roof is a good choice for split-level towers.



SWING FRAME ROOF

The Adult Love Seat and Wheel Chair Swing (page 36) are available with or without a roof.



HAPPY HIDEOUT PLAY HOUSE ROOF

All Happy Hideouts include a standard roof.



STEP 4

CHOOSE YOUR ACCESSES

Tower accesses are available in green, red, blue, black, or brown.

Children build balance and strength as they climb the accesses to their towers.

GANGPLANK

Can be easily exchanged with entrance ladder. 11' long.



GRAND GANGPLANK

Like our original Gangplank, but featuring railing instead of rope. 11' long.



ENTRANCE LADDER

Features non-slip steps and safety rails.



CHAIN LADDERS

Fastens to play set on top and bottom only. This flexibility adds excitement as well as improves balance and strengthens muscles as kids climb.

Chain ladder available in silver only.

CHAIN LADDER

For any tower with a 5' deck height and 4' or more wide.

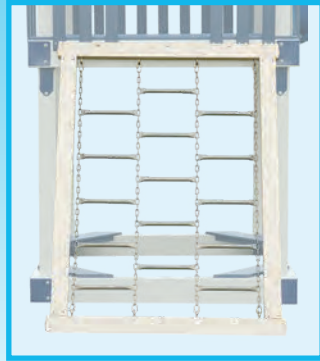

SMALL CHAIN LADDER



ROCK WALLS

A favorite among kids, rock walls can easily be added to any package. They are 5' or 7' long depending on deck height. Includes rope that is fastened at top and bottom for safety.

ROCK WALL

For 5' or 7' deck heights.



SMALL ROCK WALL

A smaller rock wall, not as wide. Not available for 7' deck heights.



Rock wall rock colors of green, red, blue, black, or gray can be uniform or mixed.

Our access options add character to trigger a world of creative adventures!

GRAND STAIRWAY

Our newest access option allows children to ascend their tower in regal style.



GRAND STAIRCASE

Five platform steps with railing and landing, approximate 8.5" rise each.



STEP 5

CHOOSE YOUR CONNECTORS

If your play set has two or more towers, or you're combining two packages, you'll need a connector.

Our crawl tube or bridge options are sure to entertain.

SWING BEAM

The swing beam also serves as a connector if opting for two or more towers.

Brackets are available in green, blue, red, brown, or black.



CRAWL TUBE

6' long • Also available in 3' long and 9' long

Available in green, blue, red, or gray.



WOBBLY BRIDGE

8' long

Hand rail colors available in green, blue, red, black, or brown.



CONNECTOR TUBE FOR TWO LEVELS

4½' long

Available in green, blue, red, or gray.

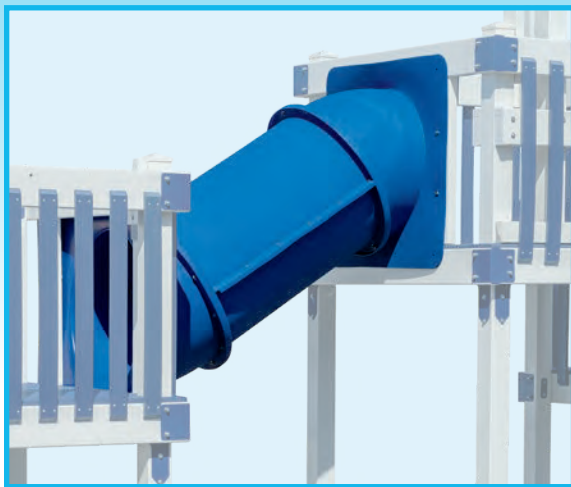

BRIDGE

8' long

Available in green, blue, red, black, or brown.



CRAWL TUBE WITH TWO ELBOWS

Available in green, blue, red, or gray.



STEP 6

CHOOSE YOUR SWING BEAM

Consider your swing beam as a blank canvas, waiting to come to life with a variety of swings.

2 POSITION SINGLE BEAM

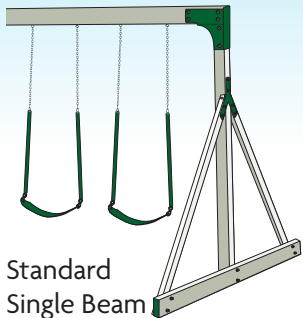

Standard Single Beam
Height is 8'

3 POSITION SINGLE BEAM

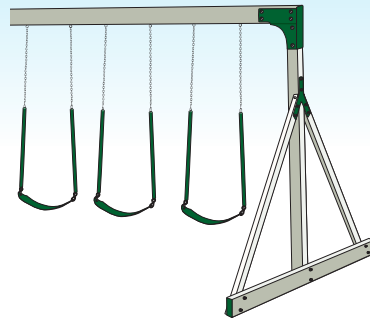

4 POSITION SINGLE BEAM

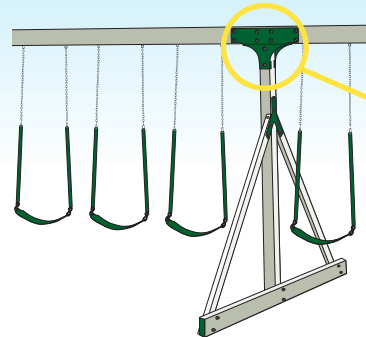

10' HIGH SWING BEAM

Available in 2, 3, or 4 positions

Requires 7' deck height or a longer post for high beam on 5' deck height.

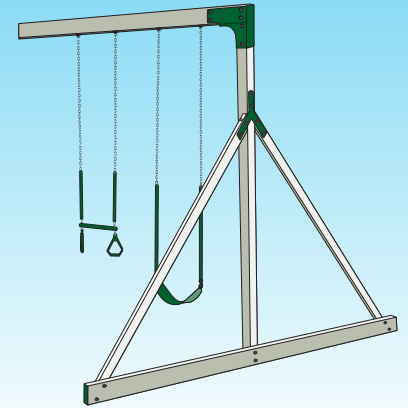

Brackets for all play sets are available in green, blue, red, black, and brown.



FREESTANDING SWING BEAM

Made by adding the second end post.



CONNECTOR BEAM ADAPTER

Allows you to extend the length of your set or add a swing beam for use with one of our tire swings!



MONKEY BAR OVERHEAD CLIMBER

A great option for connecting two towers!

Standard Overhead Climber Height is 8'

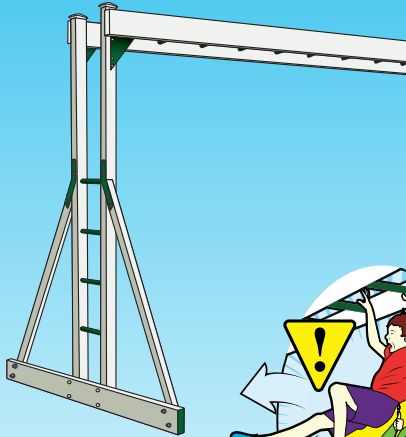

We do not recommend using the overhead climber as a swing beam due to safety concerns.



SPACE SAVER MONKEY BAR OVERHEAD CLIMBER

10' long, includes vertical ladders on both ends and a bracket to provide support at the center of the climber. Can be attached to any vertical 4x4 post.



TRAPEZE RING CLIMBER

Swinging rings challenge kids' coordination. Includes two 1-position accessory arms; chain height is adjustable.

Rings available in green, blue, red, or gray.



LOWER LEVEL SAFETY RAILING

Add lower level railing on the swing side of the tower for extra safety.



ACCESSORY ARMS

Attach to any tower or playhouse to add swings or accessories

1-POSITION 1 SIDE



2-POSITION 2 SIDES



STEP 7

CHOOSE YOUR SWINGS

Swing low, swing high toward the sky.

BELT SWING



WHEELCHAIR SWING



This swing will take up two swing spots on your swing beam.

BOLT ON GLIDERS

All require single beam adapters

BOLT ON ADAPTER



Included with vinyl horse and other plastic gliders.

PLASTIC GLIDER



VINYL HORSE GLIDER



Also available in brown.



UNI GLIDER



EASY RIDER GLIDER

Built for kids and adults, this glider swing makes a great place for adults to relax while children play.

Available in all the structural vinyl and accent colors



Easy Rider Glider shown at the end of a high beam.

ADULT SWINGS

ADULT FLAT SWING

19" wide seat.
27" overall.



HAMMOCK SWING

A great place for grown-ups to relax while the children play. Hang from a swing beam, or under a tower.



ADULT LOVE SEAT

Kids love it ... and grown-up kids will too!



Available in green, blue, red, brown, or black.

BABY SWINGS

HEAVY-DUTY HIGH BACK BABY SWING



FULL BUCKET



ADDITIONAL OPTIONS

TRAPEZE



TRAPEZE BALL



CHAIN CLIMBER SWING



CYCLONE DISKS



BALL



TIRE SWINGS

All tire swings are available with red, green, blue, or gray chain.



3-CHAIN RUBBER TIRE WITH SWIVEL



Chain Tire Swing with swivel must be capable of 360-degree rotation away from other play equipment and structures in a separate bay, under a bridge or under Happy Hideout and Giggle Junction towers, and Good Time Towers.

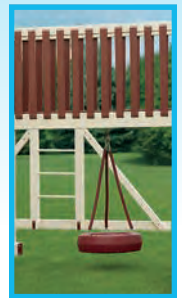

PLASTIC TIRE WITH SWIVEL



2-CHAIN RUBBER TIRE



4-CHAIN RUBBER TIRE



STEP 8

CHOOSE YOUR SLIDES

WONDER WAVE SLIDE

This 10' slide is a medium grade slide with double wall construction.

Available in 5' deck height.



5' Deck Height

RIPPLE RUSH SLIDE

This 10' slide is our highest grade slide with double wall construction.

Available in 5' deck height.



5' Deck Height

EXTREME RIPPLE RUSH SLIDE

This 14' slide is the same grade as our 10', but with a longer, more exciting ride. Requires 7' deck height and will need a Step and Slide Adapter if choosing towers with 5' deck height.

Available in 7'-9' deck heights.

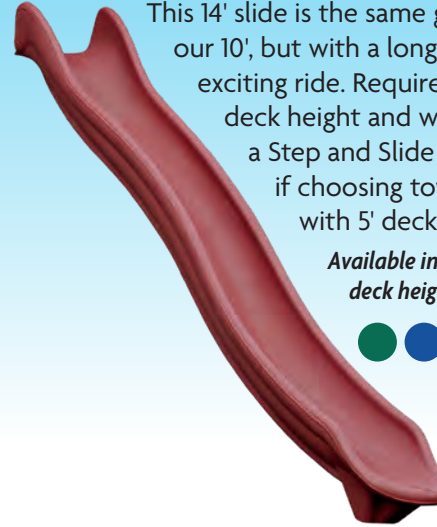

7' Deck Height

STEP AND SLIDE ADAPTER

For using Extreme Ripple Rush or 7' Twisty Turbo Tube Slides with a 5' deck height.



TUNNEL EXPRESS

Available in 3', 5', 7', & 9' deck heights.



5' Deck Height

SIDEWINDER SLIDE

Available in 3', 5', 7', & 9' deck heights.



5' Deck Height

TWISTY TURBO TUBE

Rated by kids to be our most fun slide!

Available in 7' & 9' deck heights.



Kids'
CHOICE!
★★★★★



7' Deck Height



9' Deck Height

We use only stainless steel bolts to assemble our Twisty Turbo Tube Slides.

SUPER SPIRAL SLIDE

Available in 3', 5', 7', & 9' deck heights.



3' Deck Height



5' Deck Height



7' Deck Height



9' Deck Height

CLEAR PANEL FOR TUBE SLIDES

Clear panel shown on 5' Tunnel Express



Clear panel shown on 7' Twisty Turbo Slide

STEP 9

CHOOSE YOUR ACCESSORIES

Adventure World Play Set accessories combine added entertainment with practical functionality. Ready, set...accessorize!



LEMONADE STAND

Includes two stools and one personalized plaque.

Personalized plaque can say anything you wish! Instead of "Lemonade," perhaps, "Ice Cream"



PERSONALIZED PLAQUE



SANDBOX COVER



Covers have weighted edges to keep them in place. No snaps or Velcro™ trim needed (which get full of sand).

HAND GRIP

Place at any entry point.



FIREMAN'S POLE

For a 5' deck height.

Available in red only.



TIC-TAC-TOE PANEL



BUBBLE PANEL



LOWER DECK

Available in all accent colors.



LOWER DECK WITH RAILING

Available in all accent colors.



PICNIC TABLE

Kids can enjoy a party on their own picnic table.



HIDDEN HUT

Hidden Huts include two window openings, one door opening, and lower deck floor.

Available under 5' deck height only.



PLAYHOUSE BALCONY

Includes second door on play-house.



Shown with optional Bubble Panel and Tic-Tac-Toe Panel.

CHOOSE YOUR FREE ITEM

You'll be amazed at how these simple add-ons spark excitement and imagination!

Choose one of these free items with your play set order.

STEERING WHEEL



SHIP'S WHEEL



TELESCOPE



MEGAPHONE



BINOCULARS



DETACHED SANDBOX



Remember: choose your colors (pgs. 40-41) if you haven't done so already; and don't forget rubber mulch (pg. 58) for safety.

All sets are designed and constructed for many years of safe use. For safety & comfort reasons, the manufacturer reserves the right to make design & construction changes without notice. Not intended for commercial use.

OUR CUSTOMERS

CUSTOM SETS DESIGNED BY OUR CUSTOMERS

Despite life's everyday challenges, Adventure World Play Sets create laughter and smiles that bring simple pleasures home. Here's a glimpse at some of our customers' back yards, and their custom play set creations.



WHAT OUR CUSTOMERS ARE SAYING...

We purchased an Adventure World Vinyl play station from Back Yard Living at the end of May. The unit was delivered and installed in the timeframe quoted. Adam was very helpful with information on various units and manufacturers. We decided to go with the maintenance-free, all vinyl clad swing set, play station from Adventure World. Unit was professionally and thoroughly installed yesterday. This unit is extremely well-built and solid. Backyard Living was a pleasure to work with and we are extremely satisfied with the product we chose and the company who provided unit and installed. **I would wholeheartedly recommend** Back Yard living as your go-to company for your children's play station!!

- D. Lake

Loved the 3D version of the playset. It came way before expected. The colors are bright and vibrant. Everything is super sturdy and well constructed. **My child is super excited** and will be very happy for many years to come.

- K. John

Just got a wonderful playset for our preschool. It is fantastic!! **It has been an easy experience.**

- B. Brown

Great customer service, excellent product, and fast delivery... The best part – the kids are ecstatic. After many searches for the perfect playground set, this is the best one out there. Low maintenance was an important factor for me (dad). The customization options are endless. Again, customer service was top-notch. **Highly recommended.**

- N

You will not be disappointed with these sets! We have had one for 11 years now. Just washed it off with soap and a garden hose after winter and looks like it did when new! It might seem like quite an investment up front, but is worth it. We bought when we had our first son and now have four kids playing on it! Our grandkids will use this set someday. **Worth every dollar we spent on it!**

- M. Gingerich

After carefully reviewing many playsets, we've found Adventure World to lead the play industry in quality and safety. Maintenance-free and built to last... **a choice you will not regret making!**

Excellent craftsmanship and very sturdy and durable.

-O. Burkholder

Great quality playset. Arrived quickly. Installation and **communication** through J&R Mulch, Waynesboro, PA **was excellent.**

- A. Hickman

FREQUENTLY ASKED QUESTIONS

Why vinyl?

Vinyl offers superior durability and safety as well as easy upkeep. Vinyl is fade resistant, splinter free, doesn't require staining or painting and resists wood boring insects and bees.

What's under the vinyl?

Our premium play sets use pressure-treated lumber covered by heavy-duty walled vinyl. This combines the strength of wood with the easy care and safe, smooth surface of vinyl.

What makes the play sets heavy-duty construction?

In addition to pressure-treated lumber under the vinyl covering, through-bolts and steel angles create heavy-duty corner and all-around construction. Metal powder-coated brackets and stainless steel bolts, screws and chains all resist peeling and rusting.

Can I customize my play set?

Yes! Packages featured in this catalog show our most popular requests, and help you to visualize tower options. You can order a featured package as is, or use packages to get ideas for your custom play set.

Can swings be switched or can we add to the set later?

As your children grow, baby swings can be switched for belt swings or other bigger-kid accessories. At a later date, you can also add swing beams or other features to build out your play set to accommodate changing needs and budget planning.

Why can't I attach swings to an overhead climber?

Swings on overhead climbers create a safety hazard. When in use, a child using the overhead climber can easily get hit by a swinging swing. When swings are not in use, children using the overhead climber risk getting tangled in the hanging swings. As a result, Adventure World Play Sets does not permit swings on overhead climbers.

Is there risk of the play set tipping over?

Our play sets are heavyweight and will not tip over in normal wind or use. Ground anchors also help secure swing beams firmly in place.

Does my yard need to be level?

Yes, your yard should be fairly level to safely accommodate a play set. You also will need to locate your play set six feet away from any structure or obstacle.

What type of surface is best for under our play set?

A shock-absorbing, protective surface, such as rubber mulch, is best for reducing the likelihood of injury from falls. Grass, dirt, carpet or thin mats lack the ability to absorb shock; concrete, asphalt and other hard surfaces are even more dangerous.

Are Adventure World Play Sets guaranteed?

Our play sets come with a Limited 20 Year Warranty covering defects in workmanship and materials. Slides, swings and accessories are covered by a Limited 5 Year Warranty.



RUBBER MULCH, MATS, & CURBING

A shock-absorbing, protective surface is top on the safety checklist for home playgrounds. Adventure World Play Sets recommends installing your home playground equipment over rubber mulch to reduce the likelihood of injury from falls. Grass, dirt, carpet, or thin mats are not considered protective surfaces because they lack the ability to absorb shock; concrete, asphalt or other hard surfaces are even more dangerous. Ground-level equipment – such as a sandbox – does not have an elevated play surface, and therefore does not need protective surfacing.

Note: Rubber mulch, mats and curbing are not included in play set packages.



Green Black Red Blue Brown

RUBBER MULCH

- Made from 100% recycled tire rubber.
- Non-toxic and meets federal flammability standards.
- Retains cushiony softness year round, and will not freeze.
- Stays in place even in windy conditions.
- Drains and dries quickly after it rains.
- Odor-free, non-staining and non-abrasive.
- Reduces dust and mud.
- Will not rot, attract insects, or promote insect breeding.

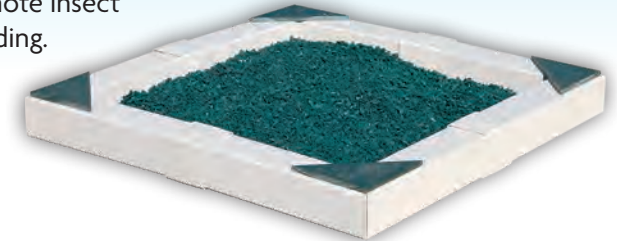

RUBBER MATS

Colorful mats help minimize erosion under swings, or at the bottom of slide exits. They provide extra protection for shock absorption.

Available in green only.

Size: 23" wide x 38" long x 1½" thick with beveled edges

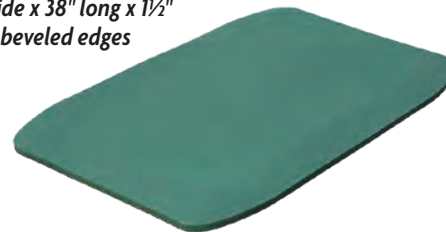

SHOCK ABSORPTION OF A FALL

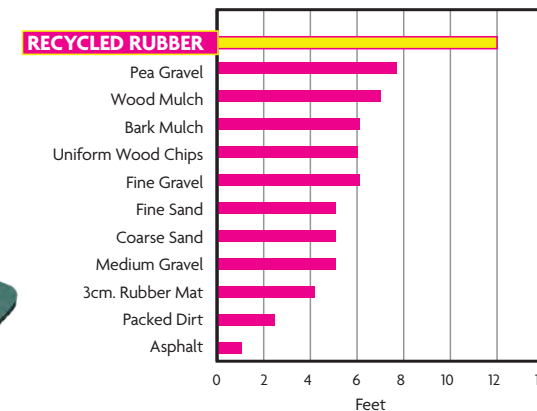

This graph represents comparison findings of playground surface materials – including recycled rubber safety surface material identical to rubber playground mulch, produced by rubber mulch using the same equipment and processes. Study completed using 6 inch depths (except where noted), by the Consumer Products Safety Commission and United States Testing Company, Inc.

STONE CURBING

- Faux stone looks natural like stone.
- Easy installation process. Hammer spikes to secure.
- Strong, durable and holds its integrity through the wear and tear of daily life.
- Rust, fade, and corrosion-resistant.
- Made in the USA.

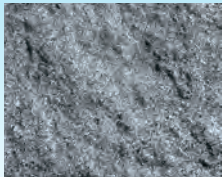

Greystone

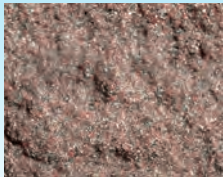

Cobblestone

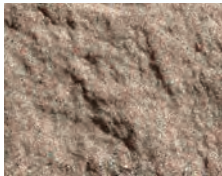

Sandstone



1 section has 6 connected blocks making it 4 feet long, 4 inches wide, and 6.5 inches tall.



Corner Blocks



Start Blocks



Stop Blocks

CURBS

Standard Border

- 4"x4" vinyl sleeve borders.
- Accommodates only square corners; does not allow rounded corners or curves.



Our 4"x4" vinyl sleeve border helps keep rubber mulch contained in play area.

Mulch and border availability may vary depending upon what your representative has to offer. Ask your representative for details.

Optional heavy-duty fabric base under the mulch prevents weeds and still allows drainage. Please kill weeds and grass prior to putting down fabric base.



Rubber Curbing

- Available in 6' lengths and 4" heights; when interlocked you will lose approximately 4" off the 6' length.
- Made from 100% recycled tire rubber.
- Allows for rounded corners and curved designs.

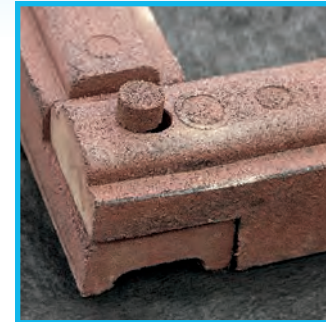

PARTS DIMENSIONS

ACCESS

Mini Rock Wall

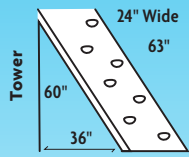

5' Rock Wall

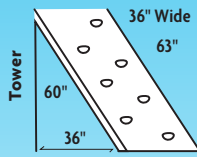

7' Rock Wall

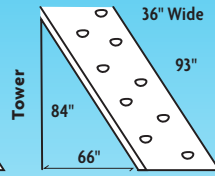

Entrance Ladder

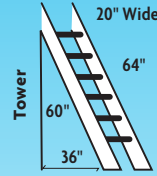

Gangplank

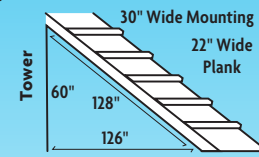

CONNECTORS

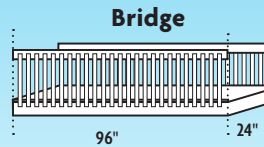
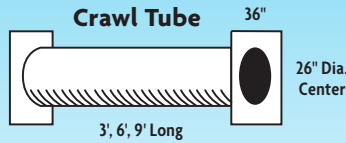

SWING BEAMS

- 2 Positions - 96" Wide
- 3 Positions - 132" Wide
- 4 Positions - 168" Wide
- 1 position outside upright

8' High
Fits 5' Deck Height

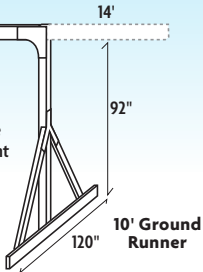

- 2 Positions - 96" Wide
- 3 Positions - 132" Wide
- 4 Positions - 168" Wide
- 1 position outside upright

10' High
Fits 7' Deck Height or Longer Post Towers Only

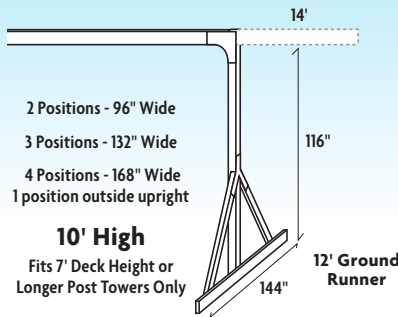

- Swing hangers are mounted on beam approximately 18" apart
- NOTE FOR GLIDER: On a single beam, put the glider adapter in the first position next to the tower.

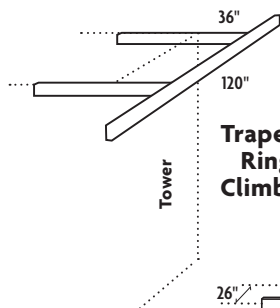
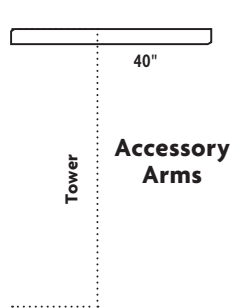

Trapeze Ring Climber

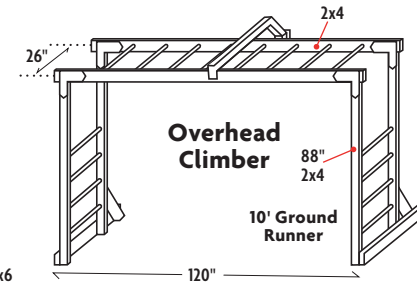

Overhead Climber

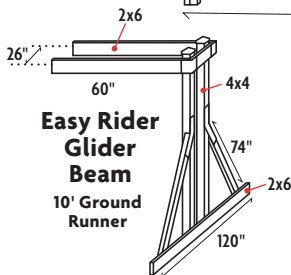

Easy Rider Glider Beam

NOTE: Do not mount accessory arms over gangplank, bridge, turbo slide or where the swing beam fastens.

SLIDES

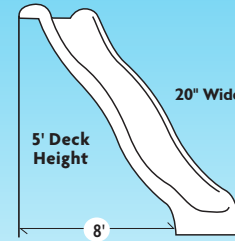

Wonder Wave

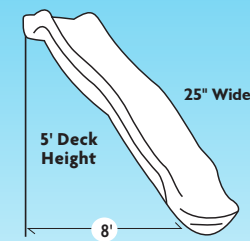

Ripple Rush

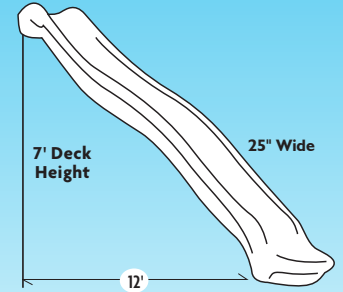

Extreme Ripple Rush

TUBE SLIDES

Twisty Turbo Tube Slide

Can be assembled to twist the opposite direction.



7' Deck Height



9' Deck Height

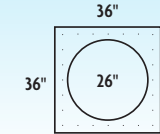
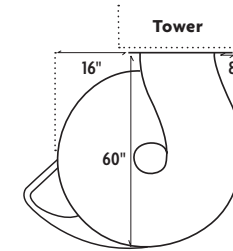
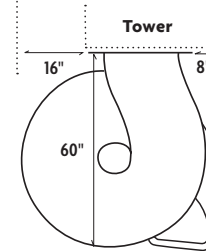

Measurements for Tube Slides

Sidewinder 3 1/2'

- For 3' Deck Height, 5'
- For 5' Deck Height, 8'
- For 7' Deck Height, 11'
- For 9' Deck Height, 13'

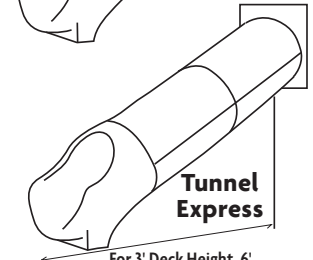
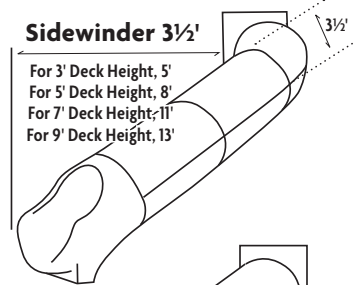

- For 3' Deck Height, 6'
- For 5' Deck Height, 9'
- For 7' Deck Height, 12'
- For 9' Deck Height, 15'

NOTE: You will need the step and slide adapter to mount a twisty turbo, extreme ripple rush slide on any 5 ft. deck.

NOTE: The tube slide comes past the tower. You do not want to put swings on this side of tower unless you do not hang a swing on the first position.